

User's Manual

BVI9994

**FULL iPod® / iPhone® CONTROL
IN-DASH DVD/MP3/CD AM/FM
RECEIVER WITH MOTORIZED
FLIP-OUT 7" (178mm) WIDESCREEN
TOUCHSCREEN TFT MONITOR
WITH DUAL (FRONT AND REAR) USB PORTS,
SD MEMORY CARD PORT, FRONT PANEL
AUX INPUT AND AND REAR PANEL AV INPUT**



BVI9994

**FULL iPod®/iPhone® CONTROL
IN-DASH DVD/MP3/CD AM/FM RECEIVER
WITH MOTORIZED FLIP-OUT 7" (178mm)
WIDESCREEN TOUCHSCREEN TFT MONITOR
WITH DUAL (FRONT AND REAR) USB PORTS,
SD MEMORY CARD PORT,
FRONT PANEL AUX INPUT AND REAR PANEL AV INPUT**

0413

BOSS®
AUDIO SYSTEMS

BOSS®
AUDIO SYSTEMS

BOSS Audio Systems is not affiliated with Apple, Inc.

PRECAUTION



WARNING: TO REDUCE THE RISK OF FIRE OR ELECTRIC SHOCK, DO NOT EXPOSE THIS APPLIANCE TO RAIN OR MOISTURE.

CAUTION: TO REDUCE THE RISK OF ELECTRIC SHOCK, DO NOT REMOVE COVER (OR BACK). NO USER SERVICEABLE PARTS INSIDE. REFER SERVICING TO QUALIFIED SERVICE PERSONNEL.



The lightning flash with arrowhead symbol, within an equilateral triangle, is intended to alert the user to the presence of uninsulated dangerous voltage within the products enclosure that may be of sufficient magnitude to constitute a risk of electric shock to persons.



The exclamation point within an equilateral triangle is intended to alert user to the presence of important operating and maintenance (servicing) instructions in the literature accompanying the appliance.

CLASS 1 LASER PRODUCT

Laser product symbol: located on the rear panel of the unit, indicate this player is a class laser product, only use weak laser and no hazardous radiation outside of the unit.

1. Read through this instruction manual before installation and use.
2. Before removing the unit, remove the disc from the unit first.
3. Do not open the cover or touch any of the components exposed out of the unit, only for qualified technicians.
4. Do not expose the unit to direct sunlight or nearby objects that radiate heat to avoid damage the unit.
5. Do not place the unit in moist and humid conditions.
6. Please ensure the ventilation holes are not covered to avoid overheating and malfunction.
7. Clear the panel and case with soft dry cloth only, do not apply any kind of thinner, alcohol or sprays.

Wires Connection Description

Description of Wires Connection

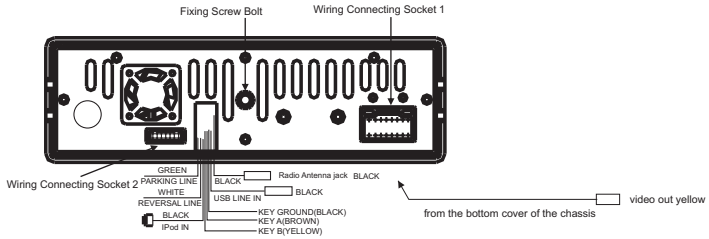

1. Parking wire must be connected. And the parking brake must be engaged in order for the monitor to work.
2. Use the clip end of the Ground Wire provided by manufacturer to connect Mounting Screw, using the other end of the Ground Wire to connect the negative pole of the power source. Otherwise, the video on screen maybe flashes.

Description of the Wiring Diagram for Socket 1

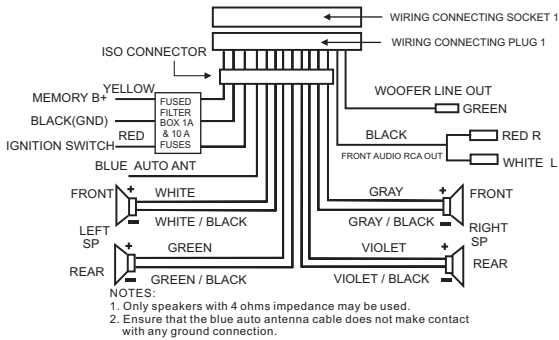

Description of the Wiring Diagram for Socket 2

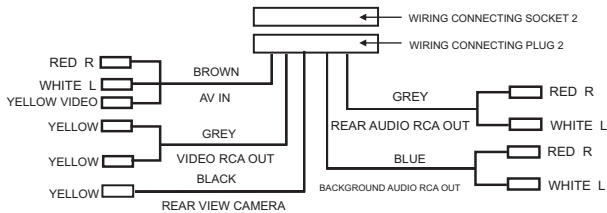

Description of Connecting the Parking Brake Line to the Parking Brake System Built in a Car

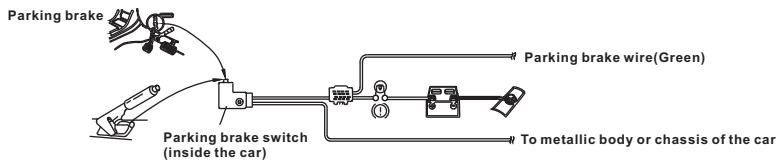

NOTE: after connecting the Parking Line, the video on the small monitor of the front panel will be display only after braking the car.

UNIT INSTALLATION

INSTALLATION INSTRUCTIONS

THE UNIT IS INSTALLED TO BE AN ANTI-THEFT ONE. THE CHASSIS OF THE UNIT WEARS A SLIDING METAL HOUSING. PLEASE DO THE CONNECTION OF THE POWER, SPEAKERS AND ANTENNA ACCORDING TO THE REQUIREMENT OF THE INSTRUCTION BOOK. THEN INSTALL THE SLIDING METAL HOUSING IN THE CAR AS FOLLOWS.

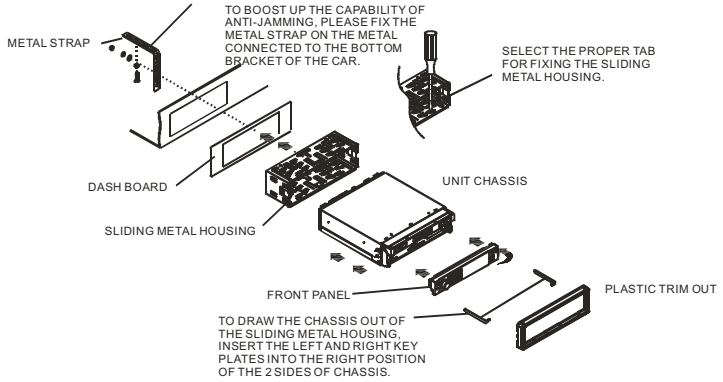

GENERAL KNOWLEDGE ABOUT REMOTE CONTROL

1. Removing insulating sheet

If using remote control for the first time, you can see an insulating sheet at the bottom side of remote control as right.

you must remove the insulating sheet as right. Otherwise, the remote control is disabled.

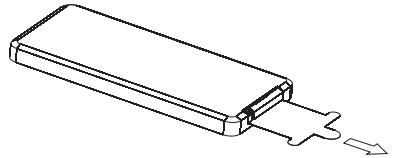

2. Replace lithium cell

If the electric energy of lithium cell is weak, replace it.

1) Press and hold the movable block as direction indicated by arrow 1 as right, at one time pull cell holder out of remote control as direction indicated by arrow 2 as right.

2) Replace the old cell by a new one with (+) polarity side upward as right.

3) Insert the cell holder into remote control again as right.

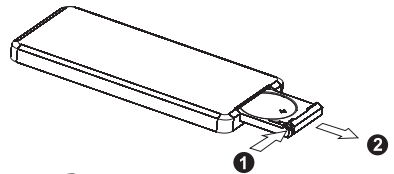

3. Note about using remote control

1) You should face the emitting window of remote control towards the sensor window of the unit.

2) Operation angle for front panel: About 30 degree

3) The distance between the emitting window of remote control and the sensor window of the unit : < 5M .

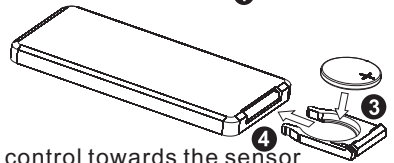

4. Warning for lithium cells of remote control

1)Cell leakage may cause damage to remote control.

2)Do not throw cells into fire, it may cause explosion.

3.To avoid risk of accident, keep cells out of reach of children.

Remote Control Description

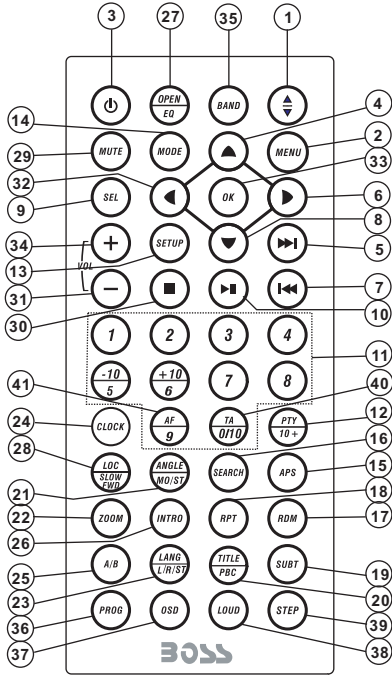

16. SEARCH BUTTON

17. RDM BUTTON

18. RPT BUTTON

19. SUBTITLE or BUTTON

20. TITLE/PBC BUTTON

21. VIEW-ANGLE or ST/MONO BUTTON

22. ZOOM BUTTON

23. LANG/L/R/ST BUTTON

24. CLOCK BUTTON

25. A-B BUTTON

26. INTRO BUTTON

27. EQ/OPEN BUTTON

28. LOC/DX or SLOW-FWD BUTTON

1. ANG BUTTON

2. MENU BUTTON

3. POWER BUTTON

4. ^ BUTTON

5. >>| BUTTON

6. > BUTTON

7. |<< BUTTON

8. v BUTTON

9. SEL BUTTON

10. PLAY/PAUSE BUTTON

11. NUMBER(0~10,+10
-10) BUTTONS

12. 10+/PTY BUTTON

13. SETUP BUTTON

14. MODE BUTTON

15. APS BUTTON

29. MUTE BUTTON

30. STOP BUTTON

31. VOLUME- BUTTON

32. < BUTTON

33. OK BUTTON

34. VOLUME+ BUTTON

35. BAND BUTTON

36. PROG BUTTON

37. OSD BUTTON

38. LOUD BUTTON

39. STEP BUTTON

40. TA BUTTON

41. AF BUTTON

Locations and Names of Controls on or in the unit

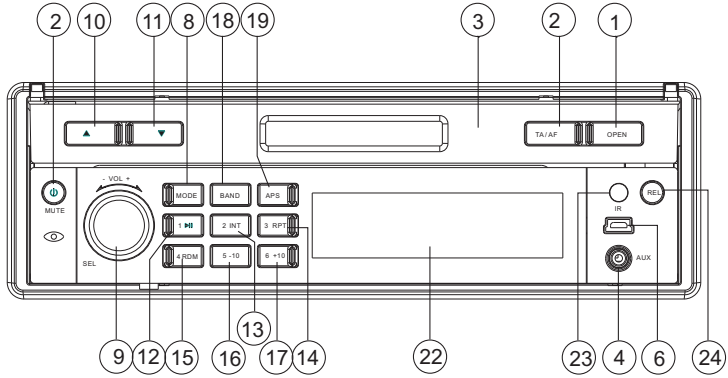

Front Panel

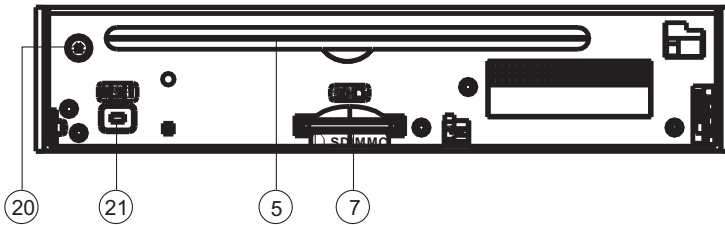

The Front Facet after removing front panel

- | | |
|----------------------------|----------------------|
| 1. OPEN button | 14. RPT/3 button |
| 2. POWER/MUTE button | 15. RDM/4 button |
| 3. Monitor | 16. - 10 / 5 button |
| 4. AUX socket | 17. + 10 / 6 button |
| 5. Disc Slot | 18. BAND button |
| 6. USB Jack | 19. APS button |
| 7. SD/MMC Card Slot | 20. EJECT button |
| 8. MODE button | 21. RESET button |
| 9. SEL button and VOL knob | 22. Small LCD Screen |
| 10. ^ button | 23. IR Remote Sensor |
| 11. v button | 24. REL button |
| 12. PLAY/PAUSE/1 button | 25. TA/AF button |
| 13. INT/2 button | |

Common Operation

1. To turn on/off the unit
In power off mode, short press any buttons except REL to turn on the unit.
In power on mode, long press the POWER button on the front panel or short press the POWER button on the remote control to turn off the unit.
2. To slide the monitor of the Car Audio System out of the chassis
Shortly press the OPEN button on the front panel or long press the OPEN button on the remote control can slide the monitor of the Car Audio System out of the chassis or slide it into the chassis.

3. To adjust the angle of the monitor
press the ^ or v button on the monitor to adjust the angle of the monitor.

4. To select function mode

Press the MODE button to select RADIO, DISC (After inserting a disc), USB(After inserting a USB storage), SD/MMC CARD(After inserting a SD/MMC card), AUX , or iPod mode.

In any mode, tapping the  icon (after popping up Key-board interface for disc/USB/card) can pop up Mode Menu 1 as right image, then touch and hold any place and slide leftward to display the Mode Menu 2 and Mode Menu 3 . finally tap one icon in the Mode Menus to enter your desired mode.



Mode Menu 1

5. To adjust sound level

Rotate the VOL knob on the front panel or press and hold the + or - button on the remote control will adjust the volume level.



Mode Menu 2

6. To adjust audio and turn on or off the touch screen
Press the SEL button continuously to switch between VOLUME, BASS, TREBLE, BALANCE and FADER. after switching on a desired audio mode above, rotate the VOL knob on the front panel or press or hold the VOL+ or VOL- button on the remote control to set it.
Long press the SEL button to turn on/off the touch screen.

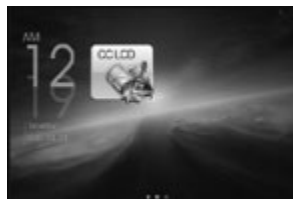

Mode Menu 3

7. To mute sound

Press the MUTE button on the remote control to turn on/off MUTE mode.

Pressing the POWER button on the front panel shortly also can turn on/off MUTE mode.

8. To display clock time

Press the CLK button to display clock time on the monitor screen.

After sliding the monitor into the chassis, pressing the CLK button can display clock time on the small LCD.

9. To select a desired EQ mode

Press the EQ button on the remote control to select one of the preset music equalizer curves: POP, ROCK, CLAS, FLAT. The sound effect will be changed.

10. To turn on/off LOUD mode

Press the LOUD button on the remote to turn on/off LOUD mode.

When turning on LOUD mode, it will enhance bass level immediately when bass is not enough.

11. To remove the front panel

press the REL button to flip down the front panel from the main unit, then hold the right end of the front panel to push leftward and pull away.

12. To reset the player

When the monitor, the small LCD display or some buttons are not working or sound is distorted, remove the front panel, then press the RESET button to reset the program to factory default.



Audio Setting

13. To calibrate the screen

To pop up Calibration interface during media playback, first press the STOP button, then press the ZOOM button, finally press the ^ and v buttons in turn.

In the interface, you can have calibration by accurately tapping the cross cursor.



Video Setting

14. AV Setting

In the Mode Menu 2 screen, tapping the AV Setting icon can pop up the AV Setting interface as right.

In the AV Setting interface, tapping the Audio or Video icon can switch between Audio Setting and Video Setting interface.

In these 2 interfaces, tapping the ◀ or ▶ icon can set one item of them.

In the Audio Setting interface, you can set the value of the VOLUME, BASS, TREBLE, BALANCE and FADER.

In the Video Setting interface, you can set the value of the BRIGHTNESS, CONTRAST, SATURATION and HUE.



the 1st Page of the General Setting

15. General Setting

In the Mode Menu 2 screen, tapping the Setting icon can pop up the 1st page of the General Setting. Then tapping one icon in the bottom row can pop up the other pages.

In these pages, tapping the ▲ or ▼ icon can select a setting item. After selecting a setting item, tap its value to set it.

In the 1st page, you can set the WALLPAPER, LOGO and BEEP.

In the 2nd page, you can set the CLOCK MODE, TIME, YEAR, MONTH and DAY.

In the 3rd page, you can set the DBAS, MBP, LOUD, EQ and REVERSE VOI.

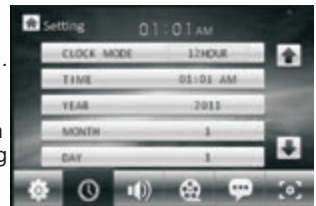

the 2nd Page of the General Setting



the 3rd Page of the General Setting



the 4th Page of the General Setting



the 5th Page of the General Setting



the 6th Page of the General Setting

In the 4th page, you can set the ASPECT RATIO, BRIGHTNESS, CONTRAST, SATURATION and STANDARD VIDEO.

In the 5th page, you can set RADIO REGION.

In the 6th page, you can calibrate the screen.

16. Backlight Setting

In the Mode Menu 2 screen, tapping the Backlight icon can pop up the Backlight Setting interface.



the Backlight Setting interface

In the interface, tapping the - or + icon can set the backlight.

17. Function setting and application for Steer buttons

In the Mode Menu 2 screen, tapping the Steer icon can pop up the Steering Control interface.



the Steering Control interface

In the interface, tapping the  icon can restore the user settings to zero and display **Please press steer the 1th key function**, then long press the 1st button in the steer to display **Please choose steer the 1th key function**, tap one function icon in the Steering Control interface such as vol-.

Set the functions of the other steer buttons as the underlined step above.

After finishing function setting of all steer buttons, tap the  icon to save.

CH- and CH+ : In radio mode, to select previous or next memory station.

Seek- and Seek+ : In disc/USB/card mode, to play previous or next track/ chapter; In radio mode, short press to manually tune down or up for a desired station, long press to automatically search down or up for an available station.

BTAn. : To receive a coming telephone.

18. Radio Rear Setup

In the Mode Menu 3 screen, tapping the Radio Rear Setup icon can pop up the Radio Rear Setup interface.



the Radio Rear Setup interface

In the interface, tapping the AV, DVD, USB, SD or iPod icon can enter the background audio output mode of the AV, DVD, USB, SD or iPod and pop up the foreground radio interface as next page.

The icons in the foreground radio interface describe as follows:

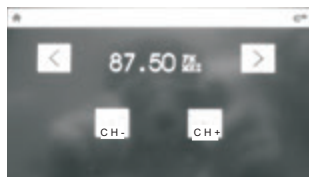

-  : To return to the Radio Rear Setup interface.
- < and > : To automatically search up or down for an available station.
- CH- and CH+ : To manually search up or down for a desired station.



the Foreground Radio interface

19. Change Color of the LCD

In the Mode Menu 3 screen, tapping the CC LCD icon can pop up the CC LCD interface.

In the interface, tapping the  or  icon can change the color of the LCD. When the RED word change to CUSTO, tapping the - or + icon can set the value of the R, G and B.



the CC LCD interface

Radio Operation

1. To enter RADIO mode(MODE button or RADIO icon)

When you use MODE button or Mode Menu 1 (tapping RADIO icon) to enter RADIO mode, it will display Radio interface 1 as right.

In the Radio interface 1, tapping the MENU icon can pop up the Radio interface 2 as right.

In the Radio interface, tapping the  icon can pop up the Volume interface 3 as right. In the Volume interface, tapping the - or + icon can adjust the volume level.



RADIO interface 1

* The functions of the icons in the radio interface are same as the same buttons in the remote control or in the main unit.

2. BAND BUTTON

In RADIO mode, press the BAND button on the remote controller or on the front panel to select your desired radio band of FM1, FM2, FM3, AM1 and AM2, and the selected band will be displayed on the small monitor on the front panel.



RADIO interface 2

3. TUNE/SEEK UP/DOWN BUTTONS

In RADIO mode:

- 1) Long press the >>| or |<< button to automatically search up or down for a available station from the current frequency.
- 2) Briefly press the >>| or |<< button to manually search up or down with step by step for your desired station from the current frequency.



RADIO interface 3

4. APS BUTTON

In RADIO mode:

- 1) When long pressing the APS button, the radio searches from the lowest frequency and checks the signal strength level until 1 cycle search is finished. And then the 6 strongest stations are preset to the corresponding preset number memory bank. The AS operation is implemented in each bank of the selected band. (It can store 3x6 stations for FM and 2x6 stations for AM)

When the AS operation is finished, it will scan each preset station for 5 seconds in FM or AM band from M1 when APS button is pressed briefly. After the scanning is finished, broadcasting will resume on the M1.

- 2) When pressing the APS button briefly, the radio will scan each preset station for 5 seconds in FM or AM band from M1. After finishing a circle of scanning, it will resume broadcasting on the M1.

NOTE: In FM band, FM1, FM2, FM3 is checked one at a time; In AM band, AM1, AM2 is checked one at a time.

5. PRESET STATION [1-6] BUTTONS

In RADIO mode:

- 1) To memorize the current frequency on the current band, long press any of the number buttons (1-6) on remote control or on the front panel .
- 2) To recall the preset memory on the current band, briefly press one of the preset buttons [1-6] on remote control or on the front panel.

6. STEREO/MONO BUTTON

Press the ST button on the remote control to select the STEREO or MONO sound mode for FM band.

7. LOC BUTTON

- 1) In RADIO mode, when the signal of the distance radio station is very weak and the receiving effect is bad during tuning. If there is the word LOC on the monitor, press this button to turn off the LOC function, then tune again for the distance radio station;
- 2) In RADIO mode, when the signal of the local radio stations are too strong and the interference doesn't allow the tuner to lock on stations, press this button to turn on the LOC function to display the word LOC on the monitor, then tune again for the local radio stations.

8. PTY (PROGRAM TYPE) BUTTON

Press the PTY button shortly to select one of the following mode:

PTY MUSIC group - - PTY SPEECH group -- OFF

When PTY group is on, press the VOL+ or VOL- button on the remote control or rotate the VOL knob on the front panel to select one of PTY programs as follows:

<-->NEWS<-->AFFAIRS<-->INFO<-->SPORT<-->EDUCATE<-->DRAMA<-->CULTURE
<-->SCIENCE<-->VARIED<-->WEATHER<-->FINANCE<-->CHILDREN<-->SOCIAL
<-->RELIGION<-->PHONE IN<-->TRAVEL<-->LEISURE<-->DOCUMENT<-->PTY
NONE<-->POP M<-->ROCK M<-->EASY M<-->LIGHT M<-->CLASSICS<-->OTHER M
<-->JAZZ<-->COUNTRY<-->NATION M<-->OLDIES<-->FOLK M<-->

When PTY group is on, pressing the 6 number buttons also can select one of PTY programs as above.

After selecting one of the PTY programs, it will display SEEK PTY and automatically search for the station of the PTY program. If the station of the PTY program does not exist, it will display PTY NONE and then return back to the normal station.

9. AF [ALTERNATIVE FREQUENCIES] BUTTON

When short press the AF button on remote control or long press the TA/AF button on the main unit, the AF switching mode is selected and the status of the AF switching mode is displayed by AF segment on the display.

Segment off: AF switching mode off.

Segment on: AF switching mode on, and has RDS information.

Segment flashing: AF switching mode on, but RDS information is not received yet.

When the AF switching mode is selected, the radio checks the signal strength of the AF all the time. The interval of checking time of each AFs depends on the signal strength of the current station, from a few minute for the strong station to a few seconds for the weak station. Every time when a new AF is stronger than the current station, it switches over to that frequency for very short time, and the NEW FREQUENCY is displayed for 1-2 second. Because the mute time of the AF switching or the checking time is very short, it is almost inaudible in case of normal program. (When AF flashes on the monitor, it will search for the stronger RDS station. If AF and TP flash on the monitor, it can only search for the traffic announcement station).

In FM mode, when AF is on, SEEK, (SCAN), AUTO-MEMORY functions can only receive and save the RDS program.

10. TA [TRAFFIC ANNOUNCEMENT] BUTTON

Press the TA button on the remote control or press the TA/AF button on the main unit to turn on TA search mode.

When traffic announcement is transmitted:

- 1). If the unit is in Disc Play mode, it will switch to radio mode temporarily.
- 2). Temporarily switches over to an station with traffic announcement, and TA, TP will be displayed on the monitor.

* TA interruption function:

The current traffic announcement is cancelled by pressing TA button briefly.

* When TA is on, SEEK, (SCAN), AUTO MEMORY functions can be received or saved only when traffic program identification code has been received.

Disc, USB and Card Operation

1. Load/unload disc , USB or Card

To play files in a disc, press the REL button to flip down the front panel, then insert the disc into the disc slot and flip up the front panel and push it onto the chassis till click, then it will automatically play . To remove the disc from the unit, press the REL button to flip down the front panel, then press the EJECT button to eject disc from the disc slot and then you can remove it.



The File Playing interface

To play files in a USB storage, firstly insert the small end of a USB cable into the mini USB port, then insert the USB storage into the big end of the USB cable, finally it will automatically play. The front and rear USB can not be played at the same time.

To remove the USB storage, directly remove it.

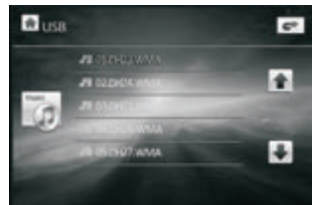

The Files List of the Playing Folder

To play files in a SD/MMC card, firstly remove the front panel, then insert the SD/MMC card into the SD/MMC card slot, finally it will automatically play.

To remove the SD/MMC card from the SD/MMC card slot, remove the front panel, push in the card and then pull it out of the Card Slot.

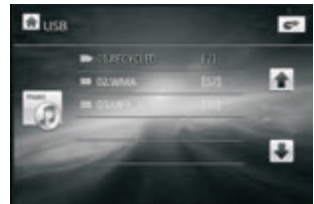

* It supports version 1.1/2.0 USB and 8 GB SD CARD.

Remark1: If the disc, USB or SD/MMC card includes MP3 or WMA files, after loading, it will display the File Playing interface as right.





The Folders List of the Playing File Format

If you want to check the directory, tap the  icon to display the Files List of the Playing Folder, the Folders List of the Playing File Format or the Root interface.

If the disc, USB or SD/MMC card includes MPEG4 or Picture files, after loading, the screen will play video. tap any place in the screen to display Keyboard and then tap the  icon to pop up the Files List of the Playing Folder, tap the  icon to pop up the Folders List of the Playing File Format or the Root interface.







The Root interface

In the Files List or Folders List interface, tapping the  or  icon can file or folder up or down.

Tapping the icon of the file, folder or file format can enter it.

In the root interface, the Music icon is for audio files; the Video icon is for image files; the Picture icon is for Video files. If there are not any files for Music, Video or Picture, you can not enter it.

In the File Playing interface, tapping any place in the rectangle of the screen can pop up the Keyboard-1 of MP3/WMA, then tapping the  icon can pop up the Keyboard-2 of MP3/WMA.

Remark2: After loading a CD disc, the screen will display the CD interface as right. In the CD interface, tapping the  icon can pop up the number interface and use the icons of the number, <-- and OK to select a desired track to play; use the  or  icon to track up or down. In the bottom row of the CD interface, it is the Keyboard-1 of CD, tapping the  icon can pop up the Keyboard-2 of CD.



Remark3: During video or image playback, tapping any place on the screen can pop up the keyboard-1 of Video/Picture as right. then tapping the  icon can pop up the Keyboard-2 or Keyboard-3 of Video/Picture as right.



- * In any work mode, tapping the progress bar can change the current start point.

All function icons are described as follows:

 : Same as  button.

 : Same as  button.

 or  : Same as  or  button.

 or  : Same as  or  button.

 : Tapping it can pop up the Volume Bar and tap the Volume Bar to adjust the volume level.

 : Same as INT button.

 : Same as LANG or L/R/ST button

 : Same as PBC or MENU button.

 : Same as TITLE button.

 : Same as REPEAT button.

 : Same as SUBTITLE button.

 : tapping it can pop up the number interface and use the icons of the number, <-- and OK to select a desired track or chapter to play

 : Same as the </>/^/v button on RC.

 : Same as zoom button.

 : Same as RDM button.

 : Same as ANGLE button.



The Keyboard-1 of MP3/WMA



The Keyboard-2 of MP3/WMA



The Keyboard-1 of CD



The Keyboard-2 of CD



The Keyboard-1 of Video/Picture



The Keyboard-2 of Video/Picture

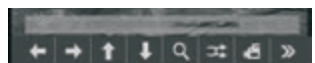

The Keyboard-3 of Video/Picture

2. Pause Playback

When playing DVD/VCD/CD/MP3/WMA , press the PAUSE button on IR remote control to pause the playback, press the PLAY button to resume normal playback.

3. Stop Playback

When playing DVD/VCD/MP3/WMA/CD , press the STOP button once to pause the playback, then press the PLAY button to resume the normal playback; press the STOP button twice to full stop the playback, then press the PLAY button to start playing from the beginning of the first chapter/track.

4. Select Chapter/Track with the >>| or |<< Button

During playback, press the >>| or |<< button to select the next or previous chapter/track to playback.

Note: Press the >>| or |<< button multiple times to advance multiple chapters /tracks forward or backward.

5. Select Chapter/Track with the Number Buttons

When playing DVD/VCD(PBC OFF)/MP3/WMA/CD , press one of the 1~9 and the 0/10 number buttons to directly select and play the 1st to 10th track /chapter (the 0/10 button is used as the 10 button).

If you want to play the track/chapter larger than 10, use the 10+, 1~9 and 0/10 button. Example 1: to play the 13th track/chapter, first press the 10+ button once, then press the 3 button. Example 2: to play the 34th track/ chapter, first press the 10+ button 3 times, then press the 4 button. (The 0/10 button is used as the 0 button)

Note: long pressing the +10 or -10 button can play the next 10th or previous 10th chapter/track(only for MP3/WMA).

6. Select Chapter/Track with the Root/PBC Menu (If the disc includes the root/PBC menu)

When playing DVD

1. Press the TITLE button on the remote control to display the title list.

2. Press the direction buttons to select your desired title, and then press the OK or PLAY button to open the root menu of the selected title.
3. Press the direction buttons to select your desired chapter, finally press the OK or PLAY button to play the selected chapter.

During playback, pressing the MENU button can directly display the root menu of the title that is playing.

In VCD mode

1. When starting to turn on the PBC function, it will play from the beginning of the disc till it display the PBC menu on TV screen if the disc include the PBC menu.
2. Press the number buttons to select your desired track to play.

In MP3/WMA mode

1. The root menu is displayed on the monitor screen all the time (and the TITLE or MENU button is not available).
2. Press the direction buttons to select your desired FOLDER, then press the OK or PLAY button to open the FOLDER, and then press the direction buttons to select your desired file, finally press the OK button to play the selected file.

In CD mode, the TITLE, PBC, MENU buttons are disabled.

7. Playback with Speed

During normal playback, long press the >>|/|<< button continuously to fast forwards or backwards at the following speeds: x2, x4, x8, x20, normal.

During speed playback, press the PLAY button to resume normal playback.

8. Playback with Slow Speed

During playback, press the SLOW_FWD button to execute the Slow Forward function.

With each consecutive pressing of the SLOW_FWD button, the playback speed decreases. The speed levels in Slow Forward as follows: x1/2, x1/3, x1/4, x1/5, x1/6, x1/7, normal.

During slow forward, press the PLAY button to resume normal playback. This function is only for video.

9. Display still frame step by step

If the unit is currently playing video, press the TEL button consecutively to display still frame step by step.

Press the PLAY button to resume normal playback.

10. Playback Repeatedly

10.1 ONE/ALL Repeat

1. In the mode of DVD playback:
Press the RPT button to select REP CHAPTER, REP TITLE, REP ALL or REP OFF.
2. In the mode of VCD(PBC OFF)/CD playback:
press the RPT button to select REP ONE, REP ALL or OFF.

When it is in the state of PBC ON, during VCD disc playing, the RPT button are not available.

3. In the mode of MP3/WMA playback:
Press the RPT button to select REP ONE, REP DIR, REP ALL or OFF.

10.2 A-B Repeat

Press the **A-B** button if you want to repeat a specific segment on a disc that you define:

1. Press the **A-B** button at a point (A) where you want it to be the start point of the repeat segment. Press the **A-B** button again at a point (B) where you want it to be the terminal point of the repeat segment. Then it will play the segment repeatedly.
2. To cancel the A-B repeat mode and resume normal playback, press the **A-B** button for the third time.

Note:

During VCD/MP3/WMA/CD playback, points A and B must be within the same track.

During DVD playback, points A and B can be selected from different chapters.

11. Playback in Scan Mode

1. When playing VCD(PBC OFF)/CD , press the INT button to play the previous 15 seconds part of each track on the disc. Press the INT button again to resume normal playback.
2. When playing DVD/MP3/WMA , the INT button is not available.

12. Playback from a specified chapter/track or a specified time

1. When playing DVD , press the SEARCH button to display a interface and highlight the title item, then use the number buttons to input the serial number of the title; use the direction buttons to highlight the chapter item, then use the number buttons to input the serial number of the chapter; you can still use the direction buttons to highlight the time item, then use the number buttons to input the desired time to start playback; finally press the OK or PLAY button to play the selected chapter or play from the selected time.
2. When playing VCD/MP3/WMA/CD , press the SEARCH button to display a interface and highlight the track item, then use the number buttons to input the serial number of the track; you can still use the direction buttons to highlight the time item, then use the number buttons to input the desired time to start playback; finally press the OK or PLAY button to play the selected track or play from the selected time.

13. Playback in Random

When playing DVD/VCD(PBC OFF)/MP3/WMA/CD , press the RDM button to switch between RANDOM (ON)/RANDOM OFF. When in RANDOM (ON) mode, it will play in random.

14. Playback in Different View-Angle

1. When playing VCD/MP3/WMA/CD , the VIEW-ANGLE button on the IR remote control is not available.
2. When playing DVD , press the VIEW-ANGLE button repeatedly on the IR remote control to view in different angle.(This function is only for the DVD media with ANGLE function)

15. Playback in Zoom Mode

In video/image mode, during playback, press the ZOOM button continuously to enlarge a certain area of the images on the screen with these multiples:

ZOOMx2,ZOOMx3,ZOOMx4,ZOOMx1/2,ZOOMx1/3,ZOOMx1/4,ZOOM OFF.
Press one of the $\wedge/v/>/<$ buttons to select the area you want to enlarge.

16. Change Caption Language

When playing DVD , press the SUBTITLE button repeatedly to select the language of the caption or turn off the caption.(depend on the media used.)

When playing VCD/MP3/WMA/CD , the button is not available.

17. Change Audio Language

1. When playing DVD , press the AUDIO button repeatedly on the IR remote control to select the desired language type. (depend on the media used)
2. When playing VCD , press the AUDIO button repeatedly to select the sound mode of the MONO L, MONO R, MIX MONO and Stereo, no language function.
3. When playing CD/WMA/MP3 , the AUDIO button is disabled.

18. Change Video Signal System

During playback of DVD/VCD , press the BAND(P/N) button on the front panel or on the remote control repeatedly to change the VIDEO SIGNAL SYSTEM mode .

19. Look over Playback Status

1. When playing DVD , press the OSD button repeatedly on the remote control to turn on/off the playback status. When it is on, it will display the information such as: the serial number of the playing title, the serial number of the playing chapter, the elapsed time of the playing chapter, the remained time of the playing chapter, the elapsed time of the playing title, the remained time of the playing title, etc.
2. When playing VCD/CD , press the OSD button repeatedly on the remote control to turn on/off the playback status. When it is on, it will display the information such as: the serial number of the playing track, the elapsed time of the playing track, the remained time of the playing track, the elapsed time of the disc, the remained time of the disc.
3. When playing MP3/WMA , press the OSD button repeatedly on the remote control to turn on/off the playback status. When it is on, it will display the information such as: the serial number of the playing track, the elapsed time of the playing track, the remained time of the playing track.

20. Program Playback

It allows you to enter the order in which you want some chapters/tracks in DVD/VCD/MP3/WMA/CD to play.

- 1 During playback, press the PROG button to enter a program interface as follows:

for DVD/MP3/WMA



for VCD/CD



- 2 Use the direction buttons to move cursor onto the desired place for inputting the sequence number.
 - 3 Use the number button to input desired sequence number of title/chapter/track with desired sequence.
 - 4 Use the direction button to move cursor onto Play item, then press the OK button to play the programmed titles/chapters/tracks in programmed order; only pressing the PLAY button also can play the programmed titles/chapters/tracks in programmed order.
- * To exit program playback, first press the STOP button, then press the PLAY button to enter sequence playback; or press the PROG button twice again.
 - * To remove all the programmed sequence numbers, move the cursor onto empty item, then press the OK button.
 - * To change the programmed sequence, move the cursor onto the item you want to change, input the desired sequence number.
 - * During VCD playback, if it is in PBC ON mode, at the same time of entering the state of program playback, it turns off PBC mode.

21. Playback IMAGE files

1. The root menu is displayed on the monitor when beginning to switch on IMAGE mode. .
In the root menu, the left file sort icon is for MP3/WMA file; the middle file sort icon is for JPEG file; the right file sort icon is for VIDEO file. If one of these 3 file sort does not exist, you can not move cursor onto the file sort icon.
2. When displaying the root menu, press the direction buttons to select your desired FOLDER, file or file sort icon, then press the OK or PLAY button to open the FOLDER, or play the selected file, or play only this sort of file.
When displaying the root menu, you can also use the number buttons to select the serial number of the file and play the file.
When you select the JPEG file sort icon, press the ^ or > button to select the first JPEG file, then press the v button to select the desired JPEG file, finally press the OK or PLAY/PAUSE button to display the JPEG picture in full screen from the selected JPEG picture.

3. During JPEG playback, press one of the >/</^/v buttons to change the angle of viewing picture that is displaying as follows:
 >: 90 deg cw; <: 90deg ccw; ^:UP<-->DOWN; v: LEFT<-->RIGHT
 During JPEG playback, press the PROG button to change the mode of refresh picture.
 During JPEG playback, press the STOP button to stop playing and return to the root menu.
- * During JPEG playback, the following buttons are not available: SLOW-FWD, SUBTITLE, TITLE, ANGLE, AUDIO, RDM, INT and A-B.
- * In JPEG mode, the other operations are same as ones in MP3/WMA mode.

22. Playback MP4 files

1. The root menu is displayed on the monitor when begins to switch on MP4 mode, then it will automatically play the first file.
 During playback, press the STOP button to stop playing and return to the root menu.
2. When displaying the root menu, press the direction buttons to select your desired FOLDER ,file or icon, then press the OK or PLAY button to open or play the selected file.
 When displaying the root menu, you can also use the number buttons to select the serial number of the file to play the file.
- * The ANGLE, PROG, RDM, INT and TITLE/PBC button are not valid.
- * The other functions are same as ones in DVD mode; but the RPT function is same as one in MP3/WMA mode.

23. ESP and ID3 Function

There is ESP function for all formats of discs.

In MP3/WMA mode, during playback, the information of the file name, folder name, song title, artist and album will be scrolling on the LCD display. As long as the current playing MP3 music contains relevant ID3 tag information in version 1.0/2.0 format, the 3 items underlined above will be scrolling on the LCD display.

24. DVD System Menu Setup Operation

1. Press the SETUP button on the remote control to access the DVD System Menu on the monitor.
2. There are 6 setup pages for the System Menu. Press the > or < button to select desired setup page.
3. Press the ^ or v button to select an setup item in the selected setup page.
4. Press the > button to enter the setup item. Then press the v or ^ button to select a desired mode of the setup item, finally press the OK button to confirm it.
- * Press the < button to return to the previous level.
- * Press the SETUP button again or use the direction buttons to highlight EXIT SETUP and then press the OK button to exit the Setup Menu.

For the DVD System Menu, there are 6 setup titles. They display as follows:

24.1 SYSTEM SETUP

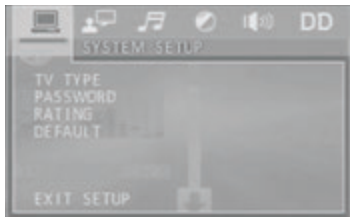

TV TYPE

The setup item is for matching monitor screen size.

- 4:3 PS: Choose this item when connecting a monitor with 4:3 screen. When playing the pictures with 16:9 size, the left and right parts of the image will be cut out, and display in full screen.
- 4:3 LB: Choose this item when connecting a monitor with 4:3 screen. When playing the pictures with 16:9 size, the top and bottom parts of the monitor will be turned into a black strip.
- 16:9: Choose this item when connecting a monitor with 16:9 wide screen.

PASSWORD

This setup item is for locking or unlocking the rating level of the Parental Control. The defaulted state is locked. The defaulted password is 0000.

You can set a new password that you like: Select the PASSWORD item and then press the > button to enter it, then input the original password 0000, and then press the OK button to unlock it. Press the > button to enter it again, then input a new password that you like and then press the OK button to make it effective. Before the other persons see the Manual, you should get the password in mind and cut out the part of PASSWORD in the Manual.

RATING

This item is for setting a new rating level of the Parental Control.

1. Select the PASSWORD item and press the > button to enter it, input the password mentioned above, and press the OK button to unlock the setting of the rating level of the Parental Control.
2. Select the RATING item and press the > button to enter it, use the direction buttons to select your desired rating level, press the OK button to confirm.
3. Select the PASSWORD item again and press the > button to enter it, input the password, and press the OK button to lock the new setting of the rating level of the Parental Control.

DEFAULT

Selecting DEFAULT will change all the settings to original factory setup.

24.2 LANGUAGE SETUP



OSD LANGUAGE

This item is for selecting the language of the SYSTEM MENU and all operating prompt interface displayed during playback.

AUDIO LANG

This item is for selecting a audio language.

SUBTITLE LANG

This item is for selecting a subtitle language.

MENU LANG

This item is for selecting a disc menu language.

24.3 AUDIO SETUP



KEY

It is for selecting your desired basic music tone(from low to high).

24.4 VIDEO SETUP



BRIGHTNESS

It is for adjusting the brightness of the video output.

CONTRAST

It is for adjusting the contrast of the video output.

HUE

It is for adjusting the hue of the video output.

SATURATION

It is for adjusting the saturation of the video output.

SHARPNESS

It is for adjusting the sharpness of the video output.

24.5 SPEAKER SETUP



DOWNMIX

It is for selecting your desired sound effect when there is not central speaker and sub-woofer. There are 3 mode: LT/RT, STEREO, VSS.

LT/RT: When playing a disc with PRO LOGIC stereo effect, choose the item, so it will output audio signal with vivid theatre effect.

STEREO: If you choose this item, when outputting audio signal with 5.1 channels, it will output the left and right channels of signal ; when outputting audio signal with 2 channels, it will output the common 2 channels of stereo signal.

VSS: If you choose this item, when playing a disc recorded with 5.1 channels, the main channel speakers can output audio signal with VSS effect.

24.6 DIGITAL SETUP



DYNAMIC RANGE

After selecting the compression mode of LINE OUT, set the item, so you can adjust the linear compression ratio. If you set it to be FULL, the Peak-to-Peak value of the audio signal is the minimum; if you set it to be OFF, the Peak-to-Peak value is the maximum.

DUAL MONO

It is for selecting a desired audio output mode for the left and right ways of signal.

It is mainly for Karaoke of Ac3. There are 4 modes in all as follows:

STEREO, MONO L, MONO R, MIX MONO.

AUX IN operation

An external AV system can use the car AV system as monitor and amplifier.

1. Use an AV cable to make the car AV system and the external AV system connected through the AUX IN jack on control panel(audio only) or the AV IN jacks from the rear cabinet of the car AV system and the AV Out jacks of the external AV system.
2. Play the external AV system, then use MODE button or the Mode Menu to enter AUX IN mode for the car AV system. By now, the program played by the external AV system can be output through the monitor of the car AV system and the speakers connected to the car AV system.
3. In AUX IN mode, you can use SEL, VOL, MUTE, EQ and LOUD buttons to adjust audio .

REAR VIEW CAMERA

The car AV system can make you look at the actual status behind your car when you change the gear level to the back position.

1. Use a video cable to make the car AV system and the rear view camera connected through the REAR CAMERA INPUT jack in the rear cabinet of the car AV system and the VIDEO OUTPUT jack of the rear view camera.

Make the REAR CAMERA SWITCH line in the rear cabinet of the car AV system connected to (B+)12V power supply.

2. In any running mode, the video signal will switch to camera mode (if applicable) when car is in reverse.

After taking the car out of reverse, it will resume to its previous mode.

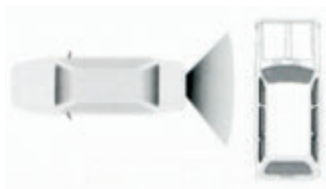

Analog on-site backup

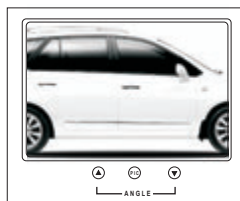

Analog on-site backup

- * Note : the external monitor can not display the actual status behind your car.

Warning:

Always check the surrounding environment. Objects might be reversed. The rear view camera is designed only to assist while reversing. Due to the limitations of the camera angle and range, it may cause accidents if the driver relies solely on the reverse camera and display.

iPod Operation

1. Enter iPod mode

When inserting the iPod plug into an iPod , it will enter iPod mode and display the File Playing interface on touch screen as follows:



The File Playing interface

You can also use MODE button or Mode Menu to enter iPod mode.

2. Popping up the Keyboard



In the File Playing interface, tapping any place in the rectangle can pop up the Keyboard as follows:



the iPod Keyboard

The functions of the icons on the iPod Keyboard are same as ones of the icons on the Keyboard of disc/USB/card.

3. Play audio files

During playback, tap the  or  icon or press the  button to pop up the iPod root as follows:



the iPod root



the iPod root

Use the v, ^ and OK button or directly tap one of the items in the rectangle to play a desired file in the iPod.

Trouble Shooting

Please read the user's manual carefully before using the DVD player. If you have any troubles in using this player, try to solve the problems by the suggestions mentioned below. If you can not remove the trouble after using all the suggestions, please contact the company or the technical service center authorized by us. For the sake of your safety, please do not open the cover and repair the player by yourself, if that, it may cause electric shock.

NO PICTURE, SOUND AND INDICATION

- * Ensure that the power switch is on.
- * Ensure that the power cord is not damaged or the fuse is not blown.
- * Ensure that the power plug is connected to the inlet tightly.

NO SOUND BUT HAVE PICTURE

- * Ensure that the player's audio output has a good connection with amplifier's audio input.
- * Check whether the audio connector is damaged.
- * Check whether you have turned down the volume.
- * Ensure that you have set the right AUDIO setup of the player.
- * Ensure that the audio is not under muted.

NO PICTURE BUT HAVE SOUND

- * Ensure that the player's video output has a good connection with monitor's video input.
- * Ensure that you have turned your monitor to the AV input channel connecting to your player.
- * Check whether the video connector is damaged.
- * Ensure that you have set the right VIDEO settings of the player.

BLACK AND WHITE PICTURE OR SCREEN ROLLING

- * Ensure that you have set the right TV SYSTEM (e.g. PAL, NTSC) setting.

FLAWS OF PICTURE OR SOUND

- * Check whether the setting of AUDIO is right.
- * Check whether the disc is scratched or stained.
- * Check whether the AV connector and the output terminal is stained.
- * Check whether there is condensation inside the Lens. If so, leave the player off for an hour or so, then try again.
- * Check whether the installation angle is less than 30° .

DISPLAY NO DISC OR BAD DISC

- * Ensure that you have put the disc in the unit.
- * Check whether the disc is put in the reverse side.
- * Check whether the disc is distorted.
- * Check whether the disc is stained or scratched badly.
- * Ensure that the disc format is compatible to the player.
- * Ensure that the temperature inside the car is not too high. If so, cool off till the ambient temperature returns to normal.
- * Replace another disc to insert it into the disc compartment.

REMOTE CONTROL IS INSENSITIVE OR DOES NOT WORK

- * Check the batteries of remote control and make sure that they are powerful and have good conductivity.
- * Direct the remote control to the IR sensor of the player.
- * Check whether there are some obstacles between the remote control and IR sensor.

SOME FUNCTION BUTTONS DO NOT WORK

- * Turn off the power, then turn on again.
- * Reset the unit to zero, then turn on again.
- * Remove the front panel from the unit, then install it again and then turn on again.

THE RADIO DOES NOT WORK

- * Check whether the antenna cable is connected firmly. Or manually tune for a station.

Specification

General Specification

Power Supply Requirement.....DC 12V
Maximum Power Output.....4 x 80W(measured at DC 14.4 V)
Dimensions(w x h x d).....7"W x 2"H x 6.3"D

DVD Deck Specification

Format.....DVD/VCD/JPEG/MP4/MP3/WMA/CD
Video System.....NTSC/PAL/PAL-M/PAL-N/AUTO(optional)
Audio System.....24 bit/96KHz
Loading System.....Auto Loading
Mounting Angle.....0 to +/-30

Video Specification

Video Type.....16:9 and 4:3
Video Output level.....Composite:1.0± 0.2Vp-p
Load impedance: 75 ohms
Horizontal Resolution.....500

Audio Specification

Audio Output(Analog audio).....2.0⁺⁰-1.0Vrms
Frequency Response.....20Hz ~ 20KHz(at 1KHz 0 dB)
S/N Ratio(Audio).....≥90dB(at 1KHz 0 dB)
Separation.....50dB

Radio Specification

FM Section

Frequency range.....87.5MHz - 107.9MHz(US)
87.5MHz - 108.0MHz(EU)
Usable sensitivity.....3uV
I.F Frequency.....10.7MHz

AM Section

Frequency.....530KHz - 1710KHz(US)
522KHz - 1620KHz(EU)